

# COLLIMATOR MOTION CONTROL SYSTEM UPGRADE FOR MEDICAL LINEAR ACCELERATOR PROJECT AT SLRI

R. Rujanakraikarn<sup>†</sup>, P. Koonpong, S. Tesprasitte  
 Synchrotron Light Research Institute, Nakhon Ratchasima, Thailand

## Abstract

A prototype of the 6-MeV medical linear accelerator has been under development at Synchrotron Light Research Institute (SLRI). A set of secondary collimators is utilized with different size arrangement for beam shaping purpose. To produce the desired field size of the beam, the FPGA-based collimator motion control is designed in VHDL for simultaneous control of the collimators while the main PI control is implemented in the FPGA's main processor. In this paper, hardware and software upgrades of the collimator motion control system are presented. A custom drive hardware for individual collimator is designed to improve with the existing FPGA controller board. Interface between the custom hardware parts and the FPGA's programmable logic (PL) part is described. Communication between the motion control subsystem and the main LabVIEW control software on PC is modified to send and receive parameters wirelessly. Software modification of the FPGA's main processor part and that of the LabVIEW GUI part is also reported.

the secondary collimators and their drive PCBs, the Digi- lent's Zedboard and the 8-channel bipolar simultaneous sampling ADC (Analog Devices' EVAL-AD7606SDZ), and the digital IP blocks designed by VHDL in the programmable logic (PL) part of the FPGA. Digital feedback control utilizing PID controller for each of the collimator and the interface between hardware and control software, including LabVIEW GUI, are also described. The performance of the developed system is very satisfactory in order to control all collimators simultaneously.

In this paper, hardware modification and upgrade are presented. In-house electronic parts and custom drive system for individual collimator and the implementation with the existing FPGA controller board is described. Wireless communication and software development, together with the data transfer to the LabVIEW GUI for monitoring purpose, are explained. System performance and conclusion are discussed at the end of the paper.

## INTRODUCTION

Currently, SLRI has been developing a prototype of the 6-MeV medical linear accelerator for cancer treatment. Reverse engineering approach has been employed in this research and development via a donated machine. The prototype consists of several subsystems, for examples, a linear accelerating structure, a 3.1-MW magnetron, a solid-state modulator, drive stand, a linac treatment head, and a central control system. All subsystems are connected to the central control system in a private network as shown in Figure 1. Introductory detail of this machine prototype can be seen in [1].

## HARDWARE

Several hardware parts of the motion control system have been designed and upgraded. Major modifications for this new system are new custom electronic PWM drive PCBs, DC power supply modules, wireless development boards, and a new ADC module. Each of them is explained in this section.

### Custom PWM Drive PCBs

Since there are two adjustable pairs of collimator jaws in the linac treatment head with one pair installed above the other to provide symmetric and asymmetric fields, the motors that move the collimators must be driven independently. Traditional H-Bridge circuit based on IR8200B is used to provide appropriate voltage to control the motor speed with PWM signal. A custom PWM drive PCB is designed to drive a motor and to receive four signals from external controller board to control IR8200B. These four signals are PWM, Direction, Brake, and Motor Enable, and they are provided by the PL part of the Zedboard controller through the rear connector of the equipment box. This custom PCB is installed in a standard equipment box as shown in Figure 2. Each box also contains a wireless development board which will be described in the subsequent subsection.

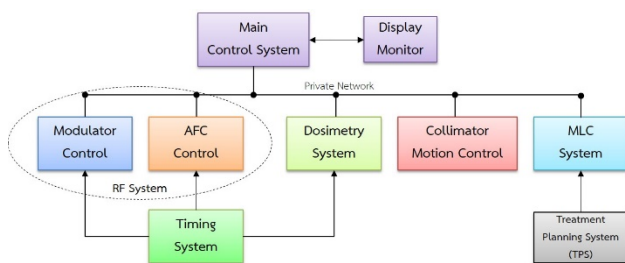

Figure 1: Network diagram of the machine prototype.

The FPGA-based motion control of collimators, both hardware platform and software implementation, is explained in detail in [1]. The main hardware parts consist of

<sup>†</sup> roengrut@slri.or.th



Figure 2: Custom PWM drive PCB installed in a standard equipment box.

The PWM drive PCB was tested using the Zedboard controller and DC power supply as shown in Figure 3. In this initial test, a small dc motor was chosen just for verification of the circuit design on the new PCB. Figure 4 shows the result of the test. One LED is turned on when the motor rotates in a clockwise direction. Similar result occurs to the other LED when the motor rotates in a counter-clockwise direction.



Figure 3: Test setup for PWM drive PCB with Zedboard controller and DC power supply.

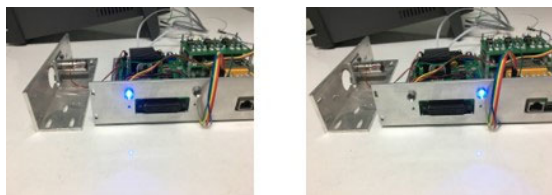

Figure 4: Test result of the new PWM drive PCB.

### DC Power Supply Modules

Several DC voltage levels are required for the collimator motion control. For the collimators, 24 volts and 27 volts are needed to supply the motors driving the upper jaws and lower jaws, respectively. The other voltage levels for electronic circuits are  $\pm 15$  volts,  $\pm 12$  volts, and 5 volts. A custom set of DC power supply modules are built for the system. They are shown in Figure 5. The installation in the standard equipment rack is shown in Figure 6.

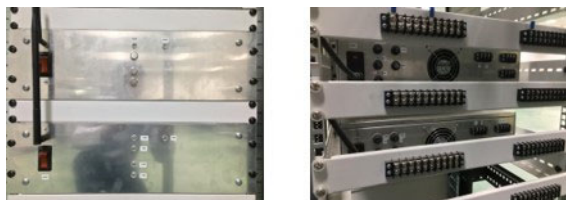

Figure 5: DC power supply modules designed in standard equipment box.



Figure 6: Equipment rack for PWM drive PCBs and DC power supply modules.

### Wireless Development Board

LinkIt Smart 7688 Duo development board [2] is chosen to be our module to communicate wirelessly with the Main Control System Software on the PC. It is an open development board based on the OpenWrt Linux distribution, MT7688 microprocessor (MPU), and ATmega32U4 microcontroller (MCU). Arduino Breakout for LinkIt Smart 7688 Duo [3] is also used to make prototyping easier through simplified wiring in order to use additional Arduino shields. The installation of the boards is also shown in Figure 2. The main reason of using this wireless module is to send collimator position data over 2.4 GHz WiFi for monitoring and redundancy purposes.

### New ADC Module

A new ADC module for sampling the position data of the collimator, which is in a form of bipolar DC voltage between -10 volts to 10 volts, is needed. An Extended ADC Shield [4] is chosen to complete this task. The 16-bit version of this shield utilizing Linear Technology LTC1859 is chosen so that it gives the same sampling resolution as that of AD7606 with the same number of channels (8 channels) but slightly lower sampling rate of up to 100 kSPS. It interfaces with the LinkIt Smart 7688 Duo development board over SPI.

## SOFTWARE

Software implementation of the upgraded system is mainly developed for LinkIt Smart 7688 Duo development board. The primary purposes are to communicate wirelessly with the Main Control System Software and to sample the collimator positions using the Extended ADC Shield. Slight modification is performed for the LabVIEW GUI on PC to receive and display this new set of data. The main C program running the feedback control algorithm on the PS part of the Zedboard controller and the AD7606 ADC Interface IP designed by VHDL on the PL part remain the same to reduce complexity of the overall design.

Implementation and interface between LinkIt Smart 7688 Duo and Extended ADC Shield is shown in Figure 7. All eight potentiometer voltages representing collimator position signals are sampled by the Extended ADC Shield. The ATmega32U4 MCU is used to communicate with the shield by SPI interface, and the control software is developed in C on Arduino IDE using Library Functions described in [4].

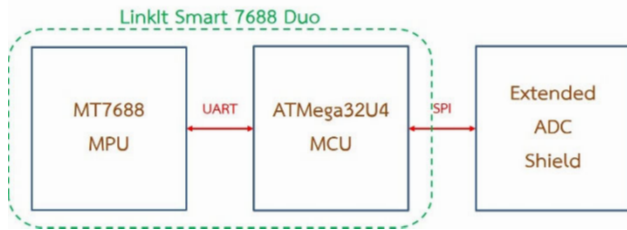

Figure 7: Interfaces between wireless development board and ADC.

Once all collimator position values are obtained by the MCU, they are sent to MT7688 MPU using UART interface. The MPU controls when to receive the data by sending either a “START” or a “STOP” command. This part of the software is developed in Python.

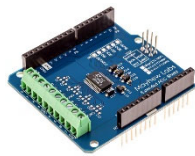

Figure 8: Extended ADC Shield [4].

On the Zedboard controller, the main C program and the AD7606 ADC Interface IP remain the same for real-time measurement and digital feedback control purposes, which can be referred to the block diagram in Figure 8 in [1]. All data from eight ADC channels of the wireless development board are sent to the GUI using 2.4 GHz WiFi. This set of data is used for position monitoring and redundancy purposes. Figure 9 shows the block diagram of the upgraded system. The LabVIEW program running a Main Control System Software is modified to receive the data via WiFi. All collimator position values received from the Extended ADC Shield are comparable to those sampled from the AD7606 daughter board of the FPGA. They are displayed on the GUI as shown in Figure 10.

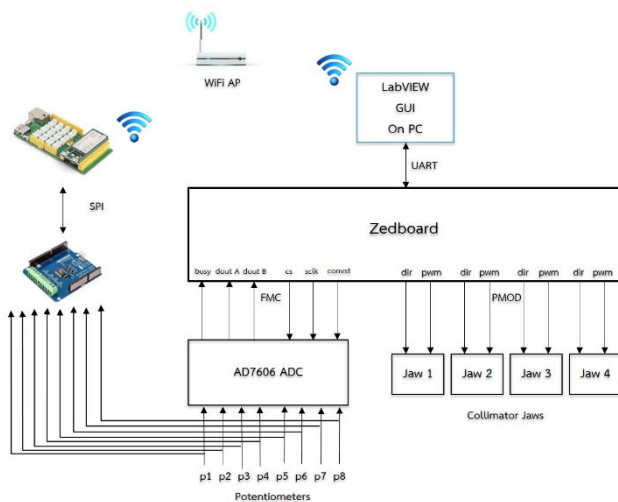

Figure 9: System block diagram of the updated system.

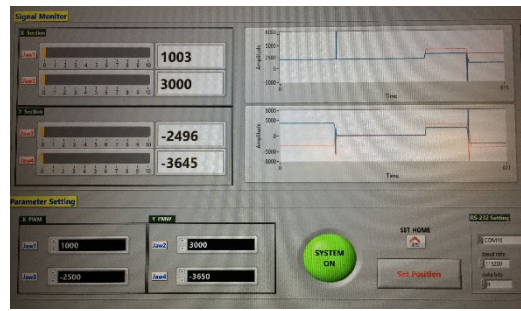

Figure 10: Main Control System Software showing collimator position values received wirelessly.

## SYSTEM PERFORMANCE

In the hardware tests, all custom PWM drive PCBs and DC power supply modules were tested very carefully. In addition to the initial test described in the Hardware section, the PWM boards were supplied with external DC voltages from the power supply modules at 24 volts for upper collimators and 27 volts for lower collimators. The Zedboard controller was used to control the motion of the collimator. This ensures the compatibility of the new hardware with an existing system. In the software tests, all programs were carefully tested and debugged to make sure all processors and controllers, together with their interfaces, work correctly. Two sets of collimator position values, one from the existing FPGA system used in feedback control and the other from the wireless system used in monitoring purpose, were compared. The error between these two data set is within 1%. Even though the sampling frequency of the ADC of the wireless system is smaller, this error is acceptable for this prototype development because its ADC has the same number of bits (16 bits) as that of the FPGA system.

## DISCUSSION AND CONCLUSION

The motion control system of the secondary collimator is upgraded. The hardware and software systems are modified to apply IoT technology to the existing system. The custom PWM drive system and DC power supply modules are designed and built. A number of tests have been performed to ensure system compatibility. The new wireless development board and 8-channel ADC module are chosen for sending collimator position values wirelessly. Initially, this new sampling system is used for monitoring and redundancy purposes only while the existing FPGA-based sampling system is used for digital feedback control. The existing LabVIEW GUI is modified to receive collimator position values from the wireless system. The resulting collimator position values from both systems are found to be comparable with small and acceptable error.

It is planned to perform further upgrades to this motion control system. It can be seen that GUI sends the desired setpoints and receives the sampled collimator position values via UART. To allow remote installation of all hardware of this motion control system, these data can be transferred wirelessly, with an appropriate interface between the Zedboard controller and the wireless development board. The

selection of either the existing ADC module driven by the FPGA logic or the new ADC shield with the SPI interface is left as an open choice since they have the same sampling resolution. In either case, real-time and simultaneous control of all collimator jaws can still be achieved.

### REFERENCES

- [1] R. Rujanakraikarn, P. Koonpong, "FPGA-Based Motion Control System for Medical Linear Accelerator Development at SLRI", in *Proc. 16th Int. Conf. on Accelerator and Large Experimental Physics Control Systems (ICALEPCS2017)*, Barcelona, Spain, Oct. 2017. doi:10.18429/JACoW-ICALEPCS2017-TUPHA069
- [2] MediaTek LinkIt™ Smart 7688 Developer's Guide (v1.1), Feb. 2016, <https://labs.mediatek.com/en>
- [3] Arduino Breakout for LinkIt Smart 7688 Duo, <https://www.seeedstudio.com>
- [4] Extended ADC Shield User Manual, 2015, <http://mayhewlabs.com>