

CONTINUOUS BEAM SCANNING INTENSITY CONTROL OF A MEDICAL PROTON ACCELERATOR USING A SIMULINK GENERATED FPGA GAIN SCHEDULED CONTROLLER

P. Fernandez Carmona, V. Minnig, G. Klimpki, D. Meer, M. Eichin, C. Bula, D. C. Weber, S. Psoroulas, Paul Scherrer Institut, 5232 Villigen PSI, Switzerland

Abstract

At the Center for Proton Therapy at the Paul Scherrer Institute cancer patients are treated with a fixed beamline and in two gantries for ocular and non-ocular malignancies. The gantries use a step-and-shoot technique to deliver dose covering the treatment volume with a grid of weighted proton bunches with different energies. Dose delivery for tumours moving under respiration is however challenging and not routinely performed, because of the interplay between patient and beam motions. At the Gantry 2 treatment unit, we are implementing a novel continuous beam modulation concept called line scanning, aiming at realizing a faster dose delivery to allow for effective organ motion mitigation techniques such as rescanning, gating or breath-hold. The beam current should stabilise within 100 μ s, which is challenging due to the non-linearity of the system and latency of the dose monitors. In this work we implemented a gain scheduled controller and a predictor by modelling the accelerator in Simulink and developing a controller using the frequency domain robust method. We used Mathwork's HDL Coder functionality to generate VHDL code that was implemented in an FPGA in the gantry control system. Latency, overshoot and dosimetry performance improved considerably compared to a classic PID controller.

INTRODUCTION

At the center for Proton Therapy in PSI we are treating cancer patients using spot scanning techniques since 1996 [1], which opened the possibility for advanced tumour treatments with protons [2, 3]. In order to push technology forward and open the possibility to treat additional sites (moving tumours like liver and lung), we are developing in our Gantry 2 a new beam delivery modality: continuous line scanning of tumours [4]. Such a technique requires controlling the intensity of the proton beam with a high precision at the 1% level, especially during fast changes, expected to happen on a sub-ms time scale.

The facility generates the proton beam with a 230 MeV superconducting cyclotron, jointly developed between PSI and the company Accel [5]. The intensity of the proton beam can be modulated near at the center of the cyclotron using two vertical deflector plates (VD) that can select how much of the beam can pass through a set of collimator slits by applying a transversal electric field [6]. In this way the radiation activation of the accelerator is minimized, as only the desired amount of protons gets accelerated to the nominal energy.

The electric field of the VD is driven by a high voltage power supply. The treatment delivery system (TDS) of

the gantry can control the beam intensity by sending the appropriate voltage set point to this power supply. The intensity of the beam that is delivered to the patient is measured with an ionization chamber monitor located at the nozzle of the gantry. Figure 1 shows the accelerator and the irradiation of a patient in Gantry 2.

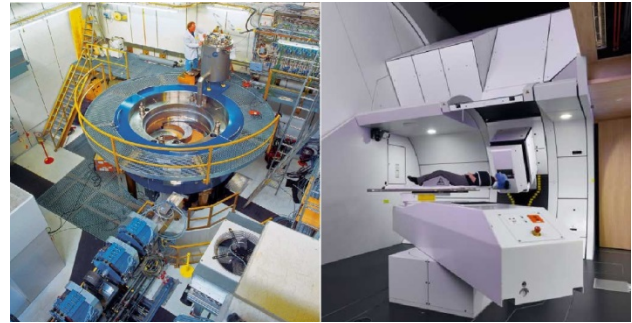

Figure 1: Cyclotron accelerator and Gantry 2, where the patients get treated with the proton beam.

For traditional spot scanning, being dose driven, the requirements for beam intensity control are not strict. However, the beam settling time and stability are crucial for a time driven delivery. In Table 1 we present the requirements for the vertical deflector voltage that were derived from the dosimetry quality required for a line scanning patient dose delivery.

Table 1 Requirements for VD Driving Voltage

Requirement	Value
Reach set point	50 μ s
Remain stable (within 10V) of set point	100 μ s
Voltage ripple	+5 V
Maximum overshoot	10 V
Full range	0-5000V

A first attempt of using a traditional PID controller in the TDS to regulate the beam intensity was used as a proof of concept [7] but precision and reproducibility were still far from clinically usable. System latency, power supply hardware limitations and variability of the accelerator behaviour are the main challenges which we had to address with a novel design.

In this article we will present how we overcame the limitations of the beam current regulation system of the accelerator by characterizing the plant over more than a year, modelling it with Matlab and generating a gain scheduled controller using Simulink's HDL coder that was then implemented in the TDS on an FPGA.

BEAM DELIVERY CHALLENGES

The proton beam extracted at the accelerator is directed through a beam line up to the Gantry 2, where patients are irradiated. The TDS is in charge of reading the prescribed patient irradiation fields and requesting the right intensity, among other parameters, from the accelerator.

Hardware Constraints

Due to the harsh radiation environment and limited space available in the accelerator bunker, the VD power supply is located outside the concrete shielding, one floor above. The cable leading the high voltage to the VD is about 35 meters long and has a capacity of 3.5 nF, the plates themselves 100 pF and together with the internal cabling adds up to 5 nF and 125 mΩ. This is an almost purely capacitive load in a typical working range of 0 to 2500 V.

To match the stringent requirements in Table 1, the supply is internally built using switched stages instead of as a monolithic device. The internal switching results in slight overshoots when the set point crosses an internal boundary, as seen in Fig. 2.

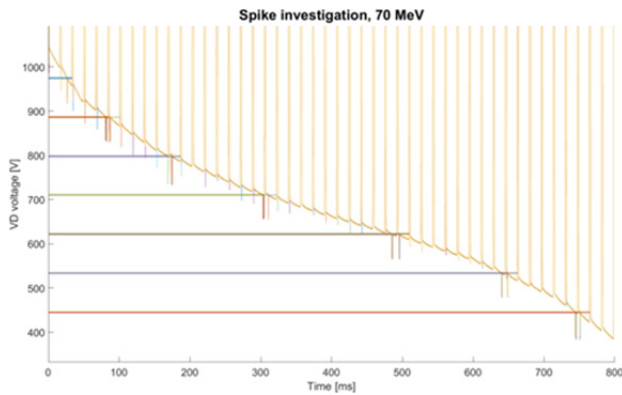

Figure 2: Sequence of consecutive lines covering a typical clinical working range, measured at the output of the VD power supply, showing voltage spikes mostly grouped at regular intervals.

A priori it is not possible to predict when the power supply will cross an internal boundary, which results in apparently random beam current overshoots. In Fig. 3 we can see how an exact same pattern applied several times results in different step responses.

Accelerator Variability

Our particle accelerator is a superconductive machine, whose magnetic field is extremely sensitive to environmental conditions. This results in delivering different beam currents on different days for the same vertical deflector voltage. In addition, the beam current extracted is related to the voltage applied at the vertical deflector in the shape of a Gaussian bell, which means that a given voltage increment results in different current changes depending on its location in the curve. Furthermore the losses of beam are different for different energies. The convolution of all these effects makes the plant highly non-linear, and control is challenging (see Fig. 4).

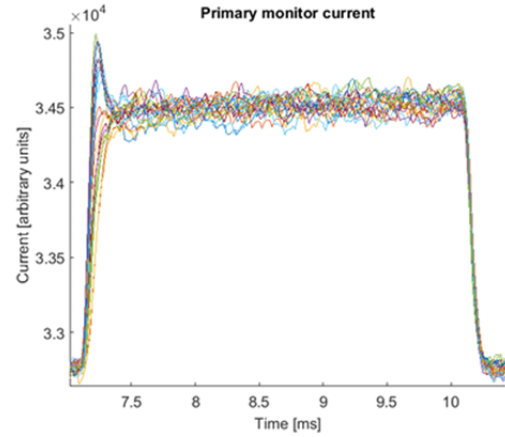

Figure 3: Superposition of 20 sequential executions of the same voltage square pattern in open loop.

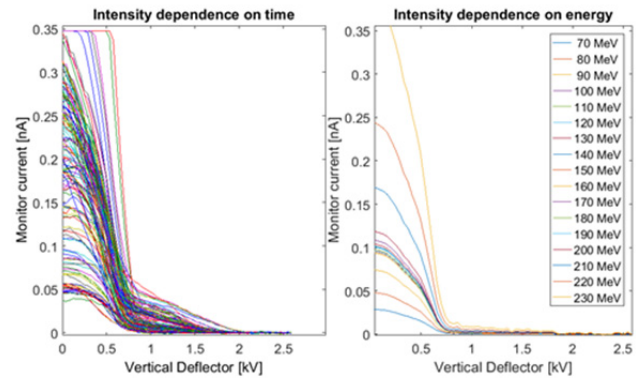

Figure 4: Beam current transfer function variation for a given vertical deflector voltage over a year for a fix energy (left) and for different energies the same day (right).

Latency

The time between the TDS software deciding a set point and the power supply output reaching it is about 80 μ s. The time between the protons passing through the vertical deflector (modulation point) and the extraction point into the beamline is 20 μ s. There is a negligible transport time in the beam line, but the collection time of the ionization monitor is approximately 90 μ s. To this, a readout time of 10 μ s of the monitor electronics is added, which computes to a total latency in the order of 200 μ s between requesting a value and measuring its effect. Latency makes intensity regulation challenging, as the reaction time is longer than most of the dynamic effects observed. As reference, in clinical practice we intend to apply lines as short as 300 μ s long.

FACILITY MODELLING

We acquired data along a year in order to get a good idea of the variability of the beam arriving at the Gantry 2. We sampled the high voltage at the output of the power supply, the set point from the control system and the beam current at the Gantry in a synchronous way with a 10 μ s time resolution. We applied random jumps between two voltage levels within the working range of the vertical deflector and classified the data according to two

variables: Overshoot of the beam current in open loop, and size of the voltage jump applied.

As shown in Fig. 5, there is a high variability in the behaviour of the facility, as the unpredictability of the power supply is amplified by the changes in the beam transfer function. For a requested intensity change, depending on the energy settings and accelerator conditions of the day, a different voltage jump will be applied. This can itself take different internal switching paths and lead to very different overshoots before reaching a stable value. It is to be noted that the smaller the jump, the higher the variability is. We divided the jumps in three areas, of low, medium and high potential overshoot.

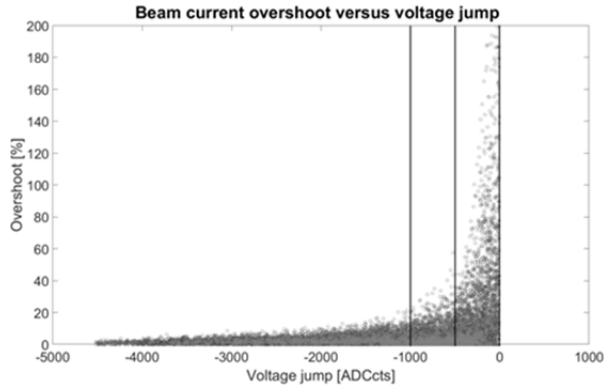

Figure 5: Random voltage jumps classified by size and beam overshoot measured [8].

The response of the accelerator, beamline and beam monitor to a given voltage jump (see measured step response in Fig. 6) can be assimilated to a second order filter and a delay.

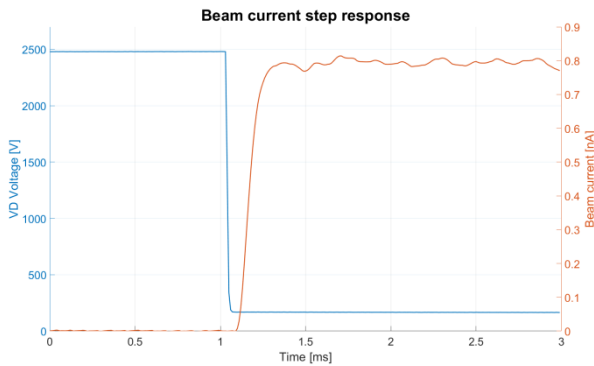

Figure 6: Accelerator control signal and dose monitor response to a voltage step.

Based on the data acquired, we created a Simulink model that would represent the facility from voltage set point to beam current detected at the ionization chamber (see Fig. 7). For each of the areas of varying potential overshoot (high, medium and low), we selected a set of evenly distributed data points (Fig. 5), and identified a set of linear models from these data points. These models were then used for the controller design. The generation of these models was automated using a Matlab GUI that takes as input a set of random voltage jumps and the resulting proton current read-out at the beam monitor. In

this way, it is possible to re-generate the model whenever the conditions of the facility change, as in the case of a parts exchange.

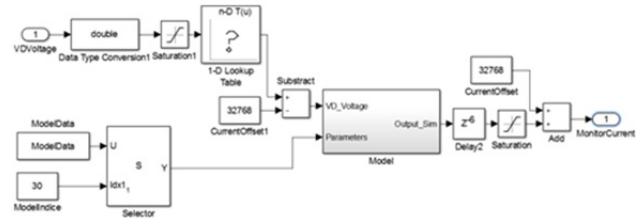

Figure 7: Main blocks of the plant modelled with Simulink.

CONTROLLER DESIGN

We took the strategy of developing a gain scheduled controller using the frequency-domain robust control (FDRC) [9] toolbox in Simulink. In this method, we define three criteria that the closed-loop system must meet: the settling time, the maximum instantaneous current overshoot and the integral dose difference. These criteria are derived from dosimetry considerations on line scanning plans, and they are the basis for calculating a desired open-loop transfer function that the optimization algorithm of the FDRC toolbox will try to approach.

For each of the three areas of varying potential overshoot discussed in the previous section, we designed a separate controller, adjusting the robustness (via the modulus margin) depending on the variability in the area. Thus, the area for the small jumps, with the largest overshoot variability, will have the most robust controller. An example of desired open-loop transfer function and robustness (modulus margin) can be seen in Fig. 8. The controllers that have been designed were of order 3. Since all of the 3 controllers (one for each area of varying potential overshoot) have the same structure, we can simply choose the parameters of the controller to be used based on the requested voltage jump.

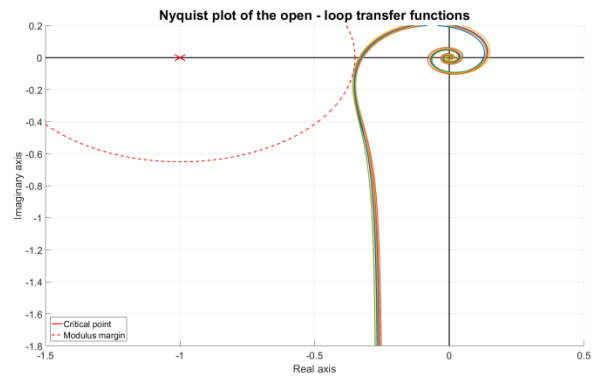

Figure 8: Definition of the stability margin of the controller on a Nyquist plot.

To cope with latency we introduced a Smith predictor in the controller, to react on the expected behaviour of the plant and to compensate for the 200 μ s delay. We chose three predictor models for our controller (one for each area of varying potential overshoot). The model chosen

for each area presents an average overshoot of that area. The full diagram is depicted in Fig. 9 and the Simulink design is shown in the Appendix. We then used the HDL coder functionality to generate the 3209 lines of VHDL code that were instantiated in the control system's FPGA, replacing our older PID controller.

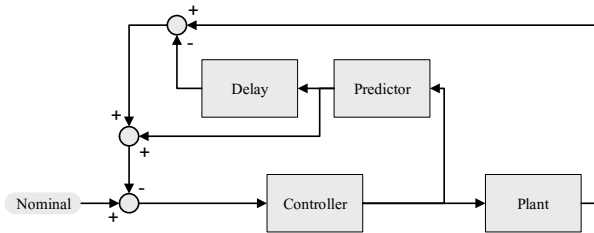

Figure 9: Structure of the new controller designed.

RESULTS

We tested the new controller, with and without latency compensation, in Gantry 2 with beam and compared it to the older PID implementation controller. In Fig. 10 the performance is compared between the new controller, with the predictor delay compensation disabled, and the older PID controller. Preliminary results in the facility show that a precise control of the beam intensity in line scanning irradiation can be achieved both in terms of instantaneous current and measured dose distribution. The line shown in Fig. 11 is a realistic example from a patient dose field, applied using the gain scheduled controller with delay compensation.

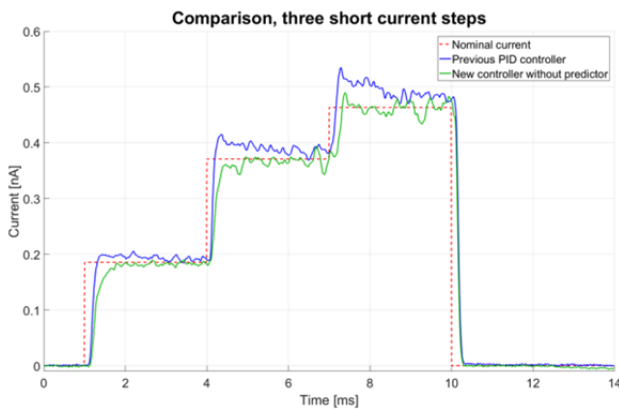

Figure 10: Comparison of PID and gain scheduled controller instantaneous beam intensity control of a line containing three consecutive steps.

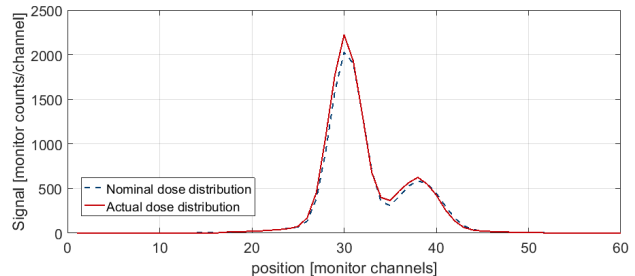
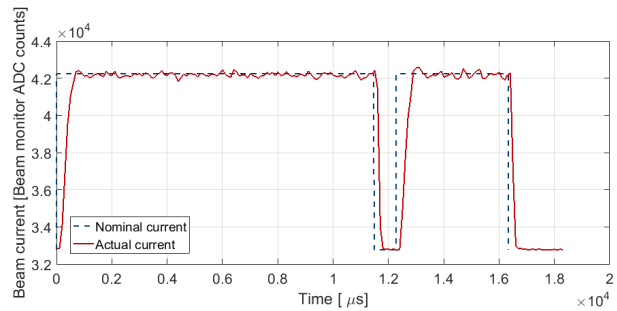

Figure 11: Experimental results with beam. Instantaneous monitor current (above) and dose profile measured at the nozzle strip chamber (below).

DISCUSSION AND CONCLUSION

We have presented the design process of a precise beam intensity controller designed for line scanning in our Gantry 2 treatment area. We modelled the facility in Simulink, developing an optimised gain scheduled controller and automatically generated VHDL code using the HDL coder tool. Designing a controller for the complex and highly non-linear facility was a challenge that required a good collaboration of physicists, controls and electricals engineers. Preliminary results show that the new controller demonstrates better performance than the standard PID in terms of settling time and overshoot.

Simulink proved to be a powerful tool to develop and optimise the controller. However, one should not underestimate the effort of adjusting the timing and synchronization elements to obtain realistic code that would match the particularities of the target FPGA. In our experience, Simulink offers great help but an understanding of the underlying hardware is still essential.

The current status of the development is testing, as reproducibility is still the biggest challenge. In the coming months we will continue adjusting the controller parameters and designing a stable solution that can be used clinically, adapting to day to day variations with minimal manual intervention.

REFERENCES

- [1] S. Lin *et al.*, “More than 10 years experience of beam monitoring with the Gantry 1 spot scanning proton therapy facility at PSI”, *Medical Physics*, vol. 36, no. 11, pp. 5331-5340, 2009.
- [2] D. C. Weber *et al.*, “Spot Scanning-based Proton Therapy for Intracranial Meningioma: Long-term Results from the Paul Scherrer Institute”, *International Journal of Radiation Oncology*Biophysics*, vol. 83, no.3, pp. 865-871, 2012.
- [3] A. Lomax *et al.*, “Treatment planning and verification of proton therapy using spot scanning: Initial experiences”, *Medical Physics*, vol. 31, no. 11, pp. 3150-3157, 2004.
- [4] A. Schätti, D. Meer, and A. J. Lomax, “First experimental results of motion mitigation by continuous line scanning of protons”, *Physics in Medicine and Biology*, vol. 59 no. 19, pp.5707–3723, 2014.
- [5] J. M. Schippers *et al.*, “The SC cyclotron and beam lines of PSI’s new proton therapy facility PROSCAN”, *Nuclear Instruments and Methods in Physics Research Section B: Beam Interactions with Materials and Atoms*, vol. 261, nos. 1–2, pp. 773–776, 2007.
- [6] J. M. Schippers, D. Meer, and E. Pedroni, “Fast scanning techniques for cancer therapy with hadrons – a domain of cyclotrons”, in *Proc. Cyclotrons’10*, Lanzhou, China, Sep. 2010, pp. 410–415.
- [7] S. Psoroulas, P. Fernandez Carmona, G. Klimpki, C. Bula, D. Meer, and C. D. Weber, “Challenges in fast beam current control inside the cyclotron for fast beam delivery in proton therapy”, in *Proc. Cyclotrons’16*, Zurich, Switzerland, Sep. 2016, pp. 126-129.
- [8] V. Minnig, “A high-precision gain-scheduled controller for the beam intensity regulation in proton therapy treatments”, Master thesis, Ecole Polytechnique Federal de Lausanne, Switzerland, 2018.
- [9] A. Karimi, “Frequency-domain robust controller design: A toolbox for Matlab”, Automatic Control Laboratory, Ecole Polytechnique Federal de Lausanne, Switzerland, 2012.

APPENDIX

Figure 12 shows the simulink controller design. The logic functionality is in grey and the colour blocks are different synchronization elements to take into account the particularities of the TDS hardware, to allow different clock domains and pipelining.

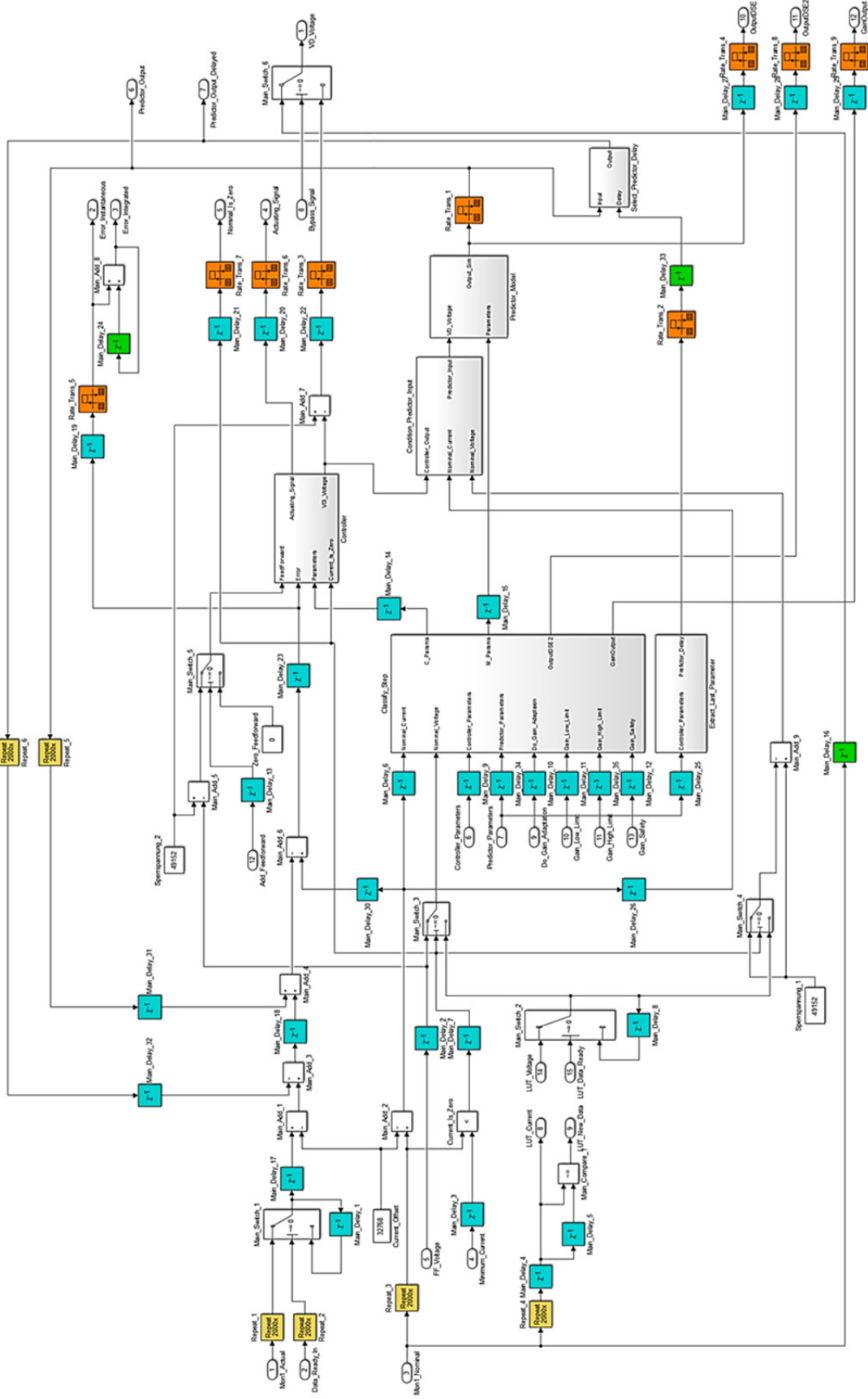

Figure 12: Simulink controller design.